

Twin Waves MKII

Dual VCO/LFO/Random - User manual

Introduction

This MKII evolution brings a redesigned layout, additional knobs for more hands-on fun and semi-modular cross-patching between sections. All of the original features are present: a top selection of synthesis techniques, each with their key parameter directly at hand, enriched by a full set of complementary features. More than ever the Twin Waves is versatility at its best.

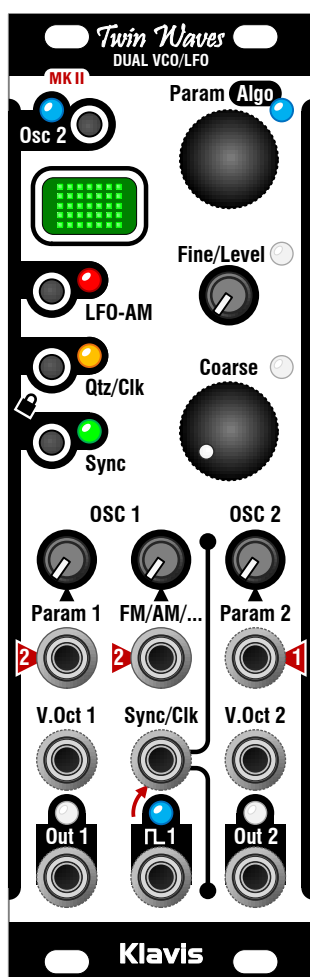

Features at a glance

- Two oscillators independently set as VCO, LFO or random
- Features in VCO mode:
 - V/Oct tracking over 10 octaves
 - Through zero and linear FM
 - Sub-octave output
 - Hard & soft synchronization
 - VCA control and CV algorithm selection
 - Quantizer with various scales
 - Algorithm-based synthesis to choose among:
 - Wave shaping
 - Phase modulation
 - Phase positioning of multiple waves
 - 5 stacked oscillators with unison detune
 - Self-sync with phantom oscillator
 - Additive synthesis (7 waves)
 - Variable bit reduction (bit-crushing)
 - Ring modulator with its own 2nd oscillator
 - Noise with LPF, BPF, or resonant VCFs
- Features in LFO mode:
 - Simultaneous signal and cycle trigger outputs
 - External wave synchronization/restart
 - Clock controlled rate with CV multiplier and divider
 - CV and knob control of output level
 - Algorithm based wave engine with a selection of:
 - Wave shaping
 - Phase modulation
 - Random levels and vectors (also Brownian)
 - Randomly spaced triggers and waves
- Display with contextual icons and instant reminder help text
- LEDs indicating potentiometer vs. value matching, switch settings and output signals
- Automatically saved settings for instant recall at power on
- Firmware update via a simple audio file

Table of Contents

INTRODUCTION	1
FEATURES AT A GLANCE	1
INSTALLATION AND SECURITY	4
PURPOSE	4
INSTALLATION	4
FIRMWARE UPDATE	5
PROCEDURE	5
FINDING YOUR WAY AROUND THE PANEL	6
HOW DOES THE CONTROLS SHARING WORK?	6
SHARING OF THE SYNC/CLK JACK.....	6
NORMALLED CONNECTIONS.....	7
VCO & LFO TERMINOLOGY	7
CONTROLS OVERVIEW	7
INPUT MODULATION POTENTIOMETERS.....	7
LOCKING THE SHARED POTENTIOMETERS	7
LFO	7
VCO	8
PARAMETER AND ALGO SHARED KNOBS	8
THE DISPLAY AND CONTEXTUAL HELP	8
AUTOSAVE	8
VCO	9
OVERALL PRESENTATION.....	9
VCO ALGORITHMS TABLE	10
V/OCT INPUT JACKS.....	11
FM/AM/... JACK.....	11
SYNCHRONIZATION – SYNC BUTTON	12
QUANTIZER – QTZ/CLK BUTTON.....	13
THE [SQUARE] 1 JACK	14
LFO	15
OVERALL PRESENTATION.....	15
LFO ALGORITHMS TABLE	15
V/OCT INPUT JACKS.....	16
CLOCK & SYNC – SYNC/CLK JACK	16
INTERNAL/EXTERNAL CLOCKING – QTZ/CLK BUTTON	16
SYNCHRONIZATION – SYNC BUTTON	17
FM/AM JACK & LEVEL KNOB	17
THE [SQUARE] 1 JACK	17
SUMMARY OF BUTTONS USE	17
SINGLE BUTTON USE	17

DUAL BUTTON USE	17
SUMMARY OF LED INDICATIONS.....	18
VCO MODE	18
LFO MODE.....	18
POTENTIOMETER LEDs.....	18
OUTPUT LEDs.....	18
TROUBLESHOOTING	19
FACTORY RESET	19
THE TUNING POTENTIOMETERS DO NOT RESPOND.....	19
NO SOUND OUT OF VCO1.....	19
NO SIGNAL IN LFO MODE.....	19
LFO IS STUCK	19
THE NORMALLED SIGNAL SEEMS MISSING	19
VCO TRACKING IS ODD.....	19
OVERALL TOPOLOGY	20
SPECIFICATIONS.....	21
MECHANICAL.....	21
SUPPLY.....	21
INPUT/OUTPUT	21
SIGNALS	21
PACKING LIST	21

Installation and security

Purpose

This module is meant for installation in a Eurorack-compliant chassis. It adheres to Eurorack mechanical and electrical specifications.

Do not attempt using this module in other mechanical or electrical contexts.

Installation

Supply current requirements

Before the installation, disconnect the mains power supply from your modular system. Some power supplies are not safely isolated; there is a risk of injury!

See in the specifications if this module requires 5V from the supply rails. If 5V is needed and your rack is not providing 5V, do not attempt connection! You can add our NoDrain supply adapter.

Check that the current consumption requirements of this module, when added to your installed set of modules do not exceed the available current from your supply. This is done by adding up the current draw of all modules (mA) separately for each of 5V, 12V and -12V rails. If any of these 3 sums exceeds the available current of your supply for that voltage, do not connect the module to your system; you need a stronger power supply.

Supply cable connection

The provided supply flat cable can only be inserted in the appropriate orientation at the back of the module, so there is no risk of error on that end. However, you should pay attention to the orientation of the cable in the socket of the supply PCB inside your chassis. Cheap sockets without shrouding may allow you to plug in the connector the wrong way!

Such inversion may bring trouble as it shorts the supply rails which in turn may destroy some sensitive module in your rack!

The red stripe on the cable should match a stripe printed on the supply board. The stripe also indicates the -12V side. In case there is no stripe, a -12V (minus 12) marking is a safe indication of the orientation.

Double check that the connectors are fully inserted and correctly oriented before switching on the power supply. In case of an anomaly, switch off the power supply immediately and check everything again.

Firmware update

Always ensure that you have the latest firmware installed before using the module.

To know the current firmware revision of your module, press simultaneously the Osc2 and Sync buttons; the display starts scrolling: “TW-REV x.xx - CAL OK”. Press any button to stop the scrolling.

The product can be updated by playing an audio file such as “TwinWaves_x.xx.wav”.

Procedure

- Connect a mono or stereo cable between your audio playing device headphone output and the Twin Waves FM/AM input.
- Prepare to play the audio file
- Set the play level at two thirds
- While pressing the Osc2 and Sync buttons, switch on your modular case supply, or press these two buttons immediately after switching on (within the first half-second).
- The green and blue LEDs are flashing
- Start playing the audio file

If everything goes fine

- The green LED is steady ON while the blue is flashing
- After a couple of seconds, the display starts filling up with dots
- When the display is full,
 - a message confirms the success of the update
 - both blue LEDs plus the green one are flashing
- Press the encoder to restart the module

If the sound level is too low

- The red LED is steady ON; the two blue LEDs are flashing
- Stop audio playback
- Slightly increase the audio playback level
- Press the encoder button; the green LED is flashing
- Start audio playback from the beginning

If there is an error during the playback

It is possible that the sound setting was too loud to begin with. There is no LED feedback in such case. Diminish the sound level drastically and restart the procedure.

Playback error can also be due to various parasitic sound causes:

- Touching the cable
- Using sound-generating features of your phone or computer
- Some power saving feature that affects the audio playback
- Surrounding noisy modules, bad electrical grounding or modular supply noise

Finding your way around the panel

The module contains two oscillators: on the left drawing, the jacks and controls of the first oscillator and on the right, those of the second one. The Sync/clk jack is available to both sections. All controls within the dotted line are somehow shared, in fact, virtually duplicated.

Section 1 controls and jacks

Section 2 controls and jacks

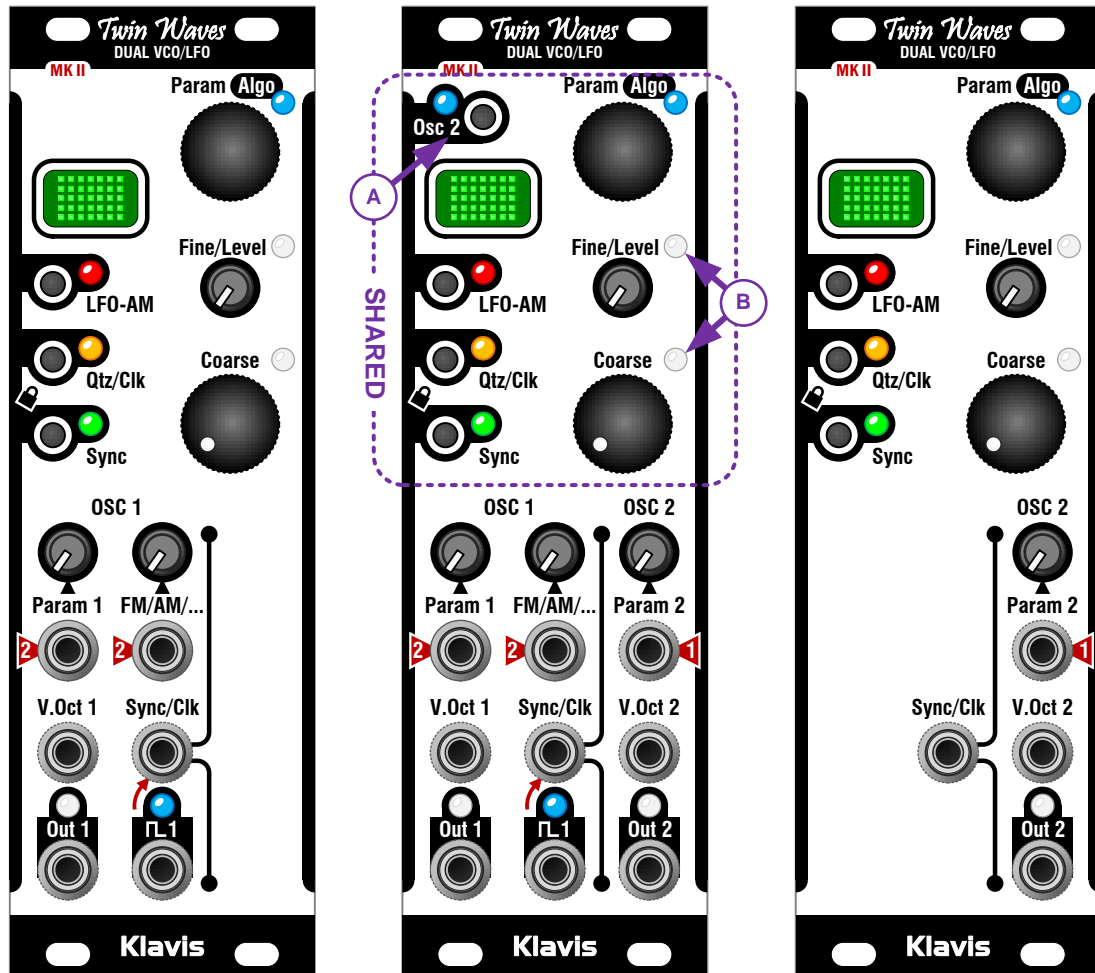

How does the controls sharing work?

The Osc2 button (A) with the blue LED determines which oscillator/section is currently selected.

When switching back and forth between the two sections, it is likely that the shared pots' positions will not reflect the actual setting they control. This is why next to each pot there's a white LED (B) that goes on as soon the pot hits the actual value. Any time the white LED is on, the pot cursor matches the value it controls. A pot only acts on the setting when its LED is on.

By design, the display and LEDs always reflect their section settings.

Sharing of the Sync/Clk jack

This jack feeds both sections and fulfills two roles in each. This sharing is solved by independently allowing the jack to play a role in each section. Details are covered in Sync and Clock chapter.

Normalled connections

Some input jacks are fed with a signal when no plug is inserted; when a plug is inserted, the internal connection is disabled. This pre-patching is called normalling.

In the Twin Waves, the red arrows tell which signal is brought in the normalled inputs.

Input jack	Normalled signal
Param 1	OSC 2 output
Param 2	OSC 1 output
Sync/Clk	OSC 1 Square/Sync output

When the outputs are used, the normalled connections remain active. This spares connecting to a "multiple" when wanting to cross modulate + use the signal out to patch elsewhere.

VCO & LFO terminology

Each section of the Twin waves can do more than a typical VCO or LFO does. We use the VCO and LFO terms as generic names to categorize the functions into Audio generation and Modulation generation.

In this manual we use the VCO and LFO terms even when dealing with features which are neither VCO nor LFO, such as filtered noise (VCO) or random vectors (LFO) according to their audio or modulation usual domain. Of course nothing prevents you from using anything to modulate anything else. 😊

Controls overview

Input modulation potentiometers

A row of 3 pots sets the gain of the 3 input jacks underneath. These are permanent – non-shared – controls.

Locking the shared potentiometers

This feature prevents accidental detuning once it is set.

By pressing simultaneously the two lower buttons (Qtz & Sync), the tuning settings of the current section can be locked/unlocked. Locking is indicated by regular flashes of the pots LEDs.

The lock icon is a reminder of the button pair involved.

LFO

The LFO button, when lit tells that the selected section is in LFO mode:

- The Qtz/Clk button gives access to clock settings
- The Sync button is always about synchronization in both VCO and LFO modes

- The Fine/Level knob is here Level, and controls the amplitude of the LFO
Think about opening this level setting when using the normalised connection: the input modulation pot may not get any signal!
- The FM/AM jack is controlling the Amplitude of the LFO 1 signal, AM/VCA thus!

VCO

When the LFO LED is off, you are in VCO mode:

- The Qtz/Clk button gives access to the pitch quantizer settings
- The Sync button is always about synchronization in both VCO and LFO modes
- The FM/AM jack offers several more control options to choose from (see later)

Parameter and Algo shared knobs

By default, the encoder controls the parameter related to the current algorithm. For example, when selecting the Square/Pulse algorithm, the associated parameter is PWM (Pulse Width Modulation). You can change that setting with the encoder and via the parameter jack.

To select another algorithm, briefly press the encoder. The Algo LED is now flashing. Turning the encoder shows the various algorithm icons in the display. Most icons are straightforward; when in doubt, there's contextual help right on the module's display.

The display and contextual help

At any time, a long press on the encoder tells you in scrolling text what you are currently selecting or controlling. This help is available in every context so that you'll never be lost. While the text is scrolling you can turn the encoder to roll the text back or move it forward. Press the encoder or any button to exit scrolling.

Autosave

Current settings are automatically saved to be restored during the next power-up. Settings should not be changed within ten seconds of switching off.

VCO

Overall presentation

In VCO mode, it is possible to activate a melodic quantizer, specific for the section, and to accept an external sync.

The oscillator 1 has two additional capabilities:

- an input jack that can be set into various control options: 2 FM modes, VCA, Quantizer base note setting, or Algorithm selection
- a sub-octave square output

The sound generation is selected from a list of algorithms belonging to one of the following categories:

Single wave algorithms

Here are the typical waves found in analog oscillators, such as triangle, sine, square and pulse. However, they can be dynamically changed in shape or phase ratio.

We have variations of true additive synthesis where sines are consecutively added to each other for bright waves that have the purity of FM synthesis and remind of drawbar organs.

Multi-oscillator algorithms

These are realized within a single section. In other words each oscillator section will generate more than one oscillator wave at once. The two sections in the Twin waves are totally independent in this regard, so both can simultaneously use a multiple oscillator algorithm if wished.

Examples of such algorithms are the Quad-saw where 4 waves act as a single one by locking their pitch relation but adjusting their phase relation, or the Unison where 5 stacked oscillators can be detuned.

Self-sync algorithms

Syncing is a typical patch that requires two oscillators. In Twin waves, each section can generate the necessary pair of oscillators. Self-sync brings screaming leads and rumbling basses that need no distortion to sound aggressive.

Ring modulator algorithm

A ring modulator is normally not a VCO feature as it requires a pair of sound sources to do its magic. Here, in a single algorithm, we provide the two necessary VCOs, each creating a pure sine. Then jointly feeding a ring modulator, they create a whole range of metallic, robotic and bell sounds.

Bit crushing algorithms

Bit crushing (also improperly called decimation) is a process applied on a sound. This process is about resampling the sound amplitude with a lower bit resolution. We have improved the usual binary-values-only approach by allowing for integer values. This offers a much smoother change





















in the effect depth. For the best effect, these algorithms use waves that present soft slopes such as saw or sine which are then broken down into staircases of variable step size. This creates a harmonically rich sound. The dynamic control of the process allows a gradual change from the original wave up to a buzzing pulse sound.

Noise algorithms

These algorithms are not based on oscillators. We start with a perfect white noise that will go through various filters, such as low-pass, variable-width band-pass and resonant. The filters cutoff frequency is controlled by the Coarse knob combined with the V.Oct (also FM for Osc 1) jacks. Their resonance or bandwidth is controlled by the parameter and its CV.

Since the filter tracks the V.Oct input, the Quantizer is available, allowing melodic noise. Sync is obviously not available with the noise algorithms.

VCO algorithms table

Icon	Algorithm	Configuration	Parameter	Parameter effect
	Sine	1 osc	Phase mod	Wave Symmetry
	Sqr/pulse	1 osc	PWM	Square to pulse waveshaping
	SawTri	1 osc	Wave shape	Triangle to saw waveshaping
	Quad saw	4-saw osc	Phase spread	Phase spreading of 4 saw waves
	Additive even	7-sine osc	Harmonics	Harmonics content
	Additive odd	7-sine osc	Harmonics	Harmonics content
	Additive all	7-sine osc	Harmonics	Harmonics content
	Unison square	3x square osc	Spread	Detuning of the 3 oscillators
	Unison saw	5x saw osc	Spread	Detuning of the 5 oscillators
	Bit-crushed saw	1 osc + BR	Bit resolution	Sample levels (integers 3 to 24)
	Bit-crushed sine	1 osc + BR	Bit resolution	Sample levels (integers 3 to 24)
	Self-sync sqr	1+1 osc	Carrier Frq	Frequency of slave oscillator
	Self-sync pulse	1+1 osc	Carrier Frq	Frequency of slave oscillator
	Self-sync saw	1+1 osc	Carrier Frq	Frequency of slave oscillator
	Self-sync tri	1+1 osc	Carrier Frq	Frequency of slave oscillator
	Self-sync sine	1+1 osc	Carrier Frq	Frequency of slave oscillator
	Ring modulator	1+1 osc +RM	Carrier Frq	Frequency of secondary oscillator
	Noise low-pass	Noise + LPF	Resonance	Filter resonance
	Noise bandpass	Noise + BPF	Band width	Filter Bandwidth
	Noise resonator	Noise + APRF	Filter gain	Quality factor

Any combination of algorithm selection is possible between the two oscillators.

V/Oct input jacks

These are meant to bring a control voltage that determines the pitch of the oscillator and respond to 1 volt per octave, thus 1/12 volt per semitone. With noise algorithms, the voltage controls the cutoff frequency of the associated filter.

When both sections are in VCO mode, a long press on the Osc2 button brings the V.Oct inputs configuration options. Setting is changed with the encoder.

Accordingly, the Osc2 LED will blink none, once, or twice per 2 seconds.

- o. **Separate** – This is the default mode where each V.Oct jack controls its related oscillator without interference with the other.
1. **Added** – The voltages brought at each V.Oct input are summed up before controlling both oscillators in parallel. The tuning, as all other settings remain completely independent.
2. **Offset** – V.Oct1 controls both oscillators in parallel. V.Oct2 adds up to the voltage sent to oscillator 2.

When at least one oscillator is set to LFO, the V.Oct jacks go into separate mode. If later returned to VCO+VCO configuration, the previous V.Oct input configuration setting is restored.

FM/AM/... jack

A long press on the LFO/AM button shows the current role of the FM/AM jack.

Turn the encoder to select one of the 5 jack roles, and then press it to apply the change.

Accordingly, the LFO/AM LED will blink none, once, twice or 3 times per 2 seconds.

- o. **BZX (FM)** – a sophisticated frequency modulation of Osc1 which is at the same time:
 - **Bipolar** – the modulation behavior is mirrored between positive or negative modulations; in other words, the wave direction is reversed twice over the full positive + negative modulation span.
 - **Through-zero** – the oscillator slows down to a stop before time reversal of the wave and increase of the frequency.
 - **Symmetrically crossing the zero frequency point** – the maximum frequency of the reversed wave at full modulation is strictly identical to the one when modulation is zero, whatever the initial frequency.
The zero points are set halfway of each modulation range, positive and negative.
1. **FM** – a moderate linear bipolar control voltage is added to the pitch of Osc1.
2. **VCA** – amplitude control of Osc1. Without control voltage, there is no sound !
3. **QTZ base note** – the voltage will define the base note of the oscillator 1 Quantizer.
See Quantizer base note on the following page.
1. **Algo** – this is a meta-control: a bipolar voltage selects an algorithm away from the one currently set manually. Note that the parameter manual setting for all algorithms is now derived from the starting algorithm setting.
The LFO/AM LED stays off; the Algo LED is flashing once every two seconds.

The BZX-FM mode is inoperative with Unison, Self-Sync and Noise algorithms.

Synchronization – Sync button

Besides offering self-sync capability, both Twin waves' oscillators can be synced in the usual way, meaning slave-synchronized to an external master oscillator.

Pressing the sync button opens the sync setting menu. Turning the encoder allows you to apply or not the sync signal from the sync jack, and in most algorithms, to choose between soft sync and hard sync.

Pressing again the sync button or the encoder will validate your selection. When steady on, the Sync LED tells that some sync is active.

Keep in mind that the sync jack being shared by the two oscillators you have to enable/disable its use in the adequate section. This is especially true with the normalling which allows you to sync OSC 1 with itself, which is useless!

Just for fun, note that even the Self-sync algorithms allow being re-synced by an additional oscillator for a sonic result which is, how to say, hmmm, judge by yourself!

Self-Sync slave tracking

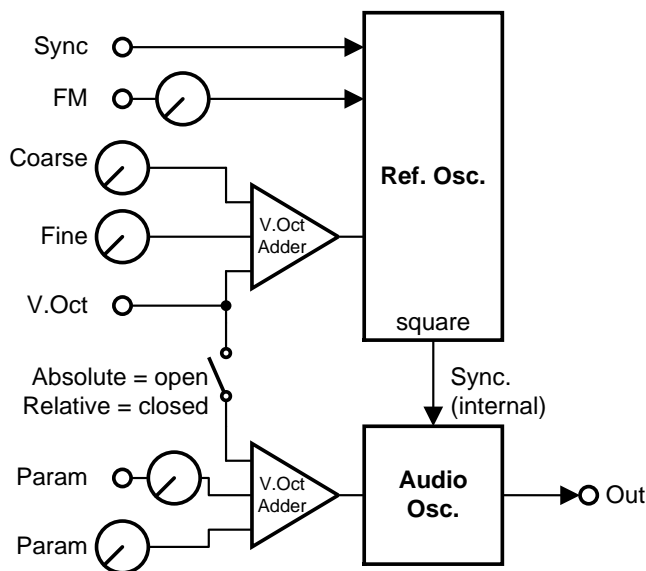

When using any of the Self-sync algorithms, an additional hidden oscillator is involved. By default the pitch of the slave oscillator is relative to the one of the master oscillator (their pitch moves jointly with V/Oct input and pitch settings of the section). A long press on the Sync button allows changing the setting of the slave oscillator between relative and absolute. In absolute mode, the Sync LED pulses once every two seconds.

Notes about soft-sync

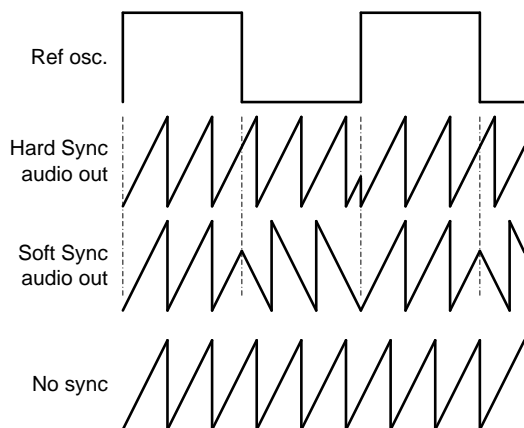

Soft sync is available in the sine and triangle self-sync algorithms as well as with external sync. In both cases, the sync signal is time-reversing the wave direction, exactly like doing thru-zero FM using a square wave as the modulation signal. Note that the frequency of the resulting wave is maintained over the direction change.

Quantizer – Qtz/Clk button

Each section has a dedicated pitch quantizer. To edit its settings, press briefly the Qtz/Clk button. The encoder allows you selecting a quantize mode or scale. Pressing the Qtz/Clk button again or the encoder validates your choice.

The Qtz/Clk LED is steady on when any quantizing is enabled.

There is one quantizer setting per section; it applies to all sound algorithms of that section.

Quantize name	Icon	Details	Base note span
Quarter tones	¼	Divides the octave in 24 equal steps	n.a.
Semitones	½	Divides the octave in 12 equal steps	n.a.
Diatonic	Di	c, d, e, f, g, a, b	12
Major	M	c, e, g	12
Minor	m	c, d#, g	12
Natural Minor	nm	c, d, d#, f, g, g#, a#	12
Pentatonic	Pe	c, d, e, g, a	12
Spanish	Sp	c, c#, e, f, g, g#, a#	12
Gamelan	Ga	c, c#, d#, g, g#	12
In Sen	IS	c, c#, f, g, a#	12
Hirajoshi	Hi	c, d#, f, g, g#	12
Blues	BL	c, d#, f, f#, g, a#	12
Chinese	Ch	c, e, f#, g, b	12
Hungarian	Hu	c, d, d#, f#, g, g#, b	12
Octatonic	8n	c, c#, d#, e, f#, g, a, a#	3
Hexatonic	Hx	c, d, e, f#, g#, a#	2
Thirds	3''	c, e, g#	4
Fifths	5''	Fifth to fifth; does not repeat over octaves!	7
Octaves	Oc	Oc	12
Just intonation	Ji	1/1, 9/8, 5/4, 4/3, 3/2, 5/3, 15/8 ratios	12
19 tones	19	Divides the octave in 19 equal steps	n.a.

A long press on the encoder allows you seeing the full name of the mode/scale selected.

The Pentatonic scale covers both major and minor variations because Pentatonic Minor is the same as Pentatonic Major when the tonic starts 3 semitones lower. So, retuning the base note and if necessary, the oscillator pitch, will do the trick.

Quantizer base note

This setting is to make the Twin Waves Quantizer match the degree of a voltage source (sequencer, keyboard, ...) that generates its V/Oct CV according to predefined notes.

Suppose a keyboard that gives 1.25V when playing C1; if you apply a quantizer that expects voltage for C being 1V, the notes allowed by the quantizer scale will not match the ones on the keyboard's keys.

Once a quantizer is active, it is possible to set its base note. The base note determines which voltage level will be the start point of the scale selected. In other words, the base note setting transposes the scale that checks the incoming volts; it does not transpose the oscillator.

If the base note for the scale is zero Volts, setting the base note 6 semitones higher will put it at 0.5V ($1\text{ V} \times 6/12$). Now, to accept a voltage that should be a C, you need 0.5V. Then to actually hear a C, you must tune the coarse and fine pots as needed.

A long press on the Qtz/Clk button displays the base note setting. It can be edited with the encoder in the usual way.

The base note can also be changed dynamically by setting the FM/AM jack to base note mode and feeding it with a voltage. In such use, the base note voltage complies with 1 V/Oct.

Root note and Base Note for the musically inclined techie

In the quantizer, the root note is always indicated as a C. Moving it to another degree is done by turning the coarse knob. This transpose happens after the quantize operation.

While the Base Note setting can give some transpose side effects, it is different in that it tunes the root note on the voltage input side of the quantizer, before the quantize operation occurs.

This is why Base Note had to have another name than Root note.

If you don't know what to do with Base Note, it is most likely because you don't need touching it. The need arises when melodic CV generators do not play what they should when passed through a Twin Waves quantizer. This is because the scale of the CV generator is already defined as a set of voltages whose "Root note/voltage" is higher/lower than the one the Twin Waves expects at its V/Oct input.

The [square] 1 jack

This output provides a square wave at half the frequency of out1. It can be used to be audio mixed but also conveniently provides a clean wave for synchronizing a slave oscillator.

LFO

Overall presentation

In LFO mode, the oscillator can be resynchronized (restarting of wave phase without affecting the cycle duration) or fully clock-synchronized (the rate is defined by external clocking).

The oscillator 1 offers two additional features:

- The amplitude of the output signal can be voltage controlled (AM)
- Trigger pulses are available on the [square] 1 output in addition to the main wave output

The LFO signals generated belong to one of the two following categories:

Cyclic signal algorithms

The most known usage of an LFO is to generate repeated waves. The triangle, square and sine offered here can all be modulated in shape or phase ratio, replacing many fixed waves such as saw and pulse. Moreover, these waves can be synchronized, which means phase-restarted by an external triggering.

Another regularly timed signal is made of random level steps generated with a sample-and-hold circuit clocked by an LFO and fed with noise; a function usually labelled S/H or S&H.

Less common is the vector generation. At each step, the current level defined randomly will progressively reach the next level also defined randomly. The end result is some kind of noise too slow to be heard but very interesting when modulating otherwise static sounds.







Aperiodic signal algorithms

The Twin waves' LFOs offer algorithms where the duration between events is irregular. This is what is called aperiodic signals.

The parameter knob and jack control the degree of timing randomness, from perfectly cyclic to widely irregular.

The aforementioned vectors and S/H algorithms each exist in their aperiodic variation.

LFO algorithms table

Icon	Algorithm	Parameter	Parameter effect
	Saw/triangle	Slope	Wave shaping between triangle and saw
	Square/pulse	PWM	Wave shaping between square and pulse
	Sine	Phase mod	Wave symmetry
	Brownian S/H	Random level maximum deviation	Randomness delta between 0 to 100%
	Randomly timed S/H	Time randomness	Spacing regularity, cyclic to random (Levels are always 100% random)
	Brownian vectors	Random level maximum deviation	Randomness delta between 0 to 100%
	Randomly timed vectors	Time randomness	Spacing regularity, cyclic to random (Levels are always 100% random)

V/Oct input jacks

These are meant to bring a control voltage that determines the frequency of the LFO and respond to $V/2F$, thus doubling/dividing the speed for every additional volt up/down. With external clock active, the V/Oct input controls the div/mult ratio (see further).

In LFO mode, the V.Oct inputs always drive their related section.

Clock & Sync – Sync/Clk jack

The LFO can be controlled by signals entering the Sync/Clk jack. The synchronization and external clocking functions are exclusive; only one of these can be active within a given section. With LFOs in both sections, it is allowed having one of them with its Sync active, while the other is set to external clocking. Both will obey to the same external signal.

Internal/external clocking – Qtz/Clk button

The default use of an LFO is to be the master of its rate. The rate is controlled by the Coarse knob and V.Oct input. Alternatively, the Twin waves LFO can be synchronized to an external clock or any periodic trigger/gate/LFO signal. Moreover, it is possible to define a ratio between that external cyclic signal and the rate of the Twin Waves LFO.

Briefly pressing the Qtz/Clk button enters the LFO clock settings. The options are: internal clock (ic) and external clock (xc). These are selected and validated by the encoder.

When external is selected, the Qtz/Clk LED will be on. Now, instead of setting the rate, the Coarse pot allows selecting the multiply or divide ratio applied to the incoming clock.

The rate is defined by the time elapsed between consecutive incoming clock ticks.

Clocks ticks spaced several minutes apart can lead to cycles of several hours when divided by 64.

A voltage brought to the V/Oct jack is added to the Coarse knob setting to determine the division/multiplication ratio applied.

Multiplication and division ratios	
16x	/1.5
12x	/2
9x	/3
8x	/4
6x	/6
4x	/8
3x	/9
2x	/12
1.5x	/16
1x	/32
	/48
	/64

When activating external clocking, the Sync function within the same section is unavailable.

Synchronization – Sync button

With sync active, every trigger/gate signal brought to the Sync/Clk jack will instantly start a new LFO cycle.

Pressing the sync button opens the sync setting menu. Turning the encoder allows you to apply or not the sync signal from the sync jack. With cyclic algorithms, you can choose between rising edges, falling edges, or both. Random algorithms only allow rising edge synchronization.

Pressing again the sync button or the encoder will validate your choice. The Sync/Clk LED is steady on when synchronization is enabled.

When activating Sync, external clocking in the same section is not available.

Keep in mind that the sync jack being shared by the two oscillators you have to enable/disable its use in the adequate section.

FM/AM jack & Level knob

The CV in at this jack adds up with the setting of the (Fine/) Level knob to control the amplitude of LFO 1. Negative voltages can close down a level set up with the knob.

LFO 2 offers only knob control.

The [square] 1 jack

This jack issues a short trigger pulse at the beginning of every wave cycle. It can be used to clock external devices. It is particularly useful when using the random timing algorithms.

Summary of buttons use

Single button use

Button	Short press	Long press
Osc 2	Toggles the panel between Osc 1 & 2	V/Oct jacks configuration editing
LFO/AM	Toggles between VCO & LFO modes	FM/AM jack usage editing
Qtz/Clk	<ul style="list-style-type: none">Quantizer settings when VCOClock settings when LFO	Quantizer base note selection when quantizer is active
Sync	Sync settings	Relative/Absolute setting with Self-Sync algorithms

Dual button use

Combo	Function
Osc 2 + Sync	Display the firmware revision and calibration status
Qtz/Clk + Sync	Lock/unlock the tuning pots in the current VCO

Dual button - before powering on

Combo	Function
Osc 2 + Sync	Prepare for firmware update
LFO/AM + Qtz/Clk	Reset to factory default settings

Summary of LED indications

Depending on a function being on or off, pulses might be inverted (black blips).

VCO mode

When LFO/AM red LED is (mostly) off

LED		Off	On	Blink	Pulse	Double pulse	Triple pulse
Osc2	Blue	VCO 1 selected	VCO 2 selected,	Editing V/Oct jacks	V/Oct = Added	V/Oct = Offset	
LFO/AM	Red	VCO, FM jack = BZX	See LFO mode	Editing FM jack	FM jack = Lin FM	FM jack = AM (VCA)	FM jack = Qtz base note
Qtz/Clk	Yel		Qtz = on	Editing Qtz			
Sync	Green		Ext sync = on	Editing Sync algos	Slave osc is absolute		
Algo	Blue			Select Algo	FM jack = Algo		

LFO mode

When LFO/AM red LED is (mostly) on

LED		Off	On	Blink	Pulse
Osc2	Blue	LFO 1 selected	LFO 2 selected		
LFO/AM	Red	See VCO mode	LFO, FM jack = AM		Cycle start
Qtz/Clk	Yel		Ext clock = on	Editing clock	
Sync	Green		Ext sync = on	Editing sync	
Algo	Blue			Select Algo	

Potentiometer LEDs

LED		Off	On	Pulse
Pot LEDs	White	Knob <> setting	Knob = setting	Knobs locked

Output LEDs

Output white LEDs follow the shape of the signal, where LED off = max negative, and full on = max positive. Beware that this indication is independent from the actual amplitude of the signal coming out of the jack!

The Sqr1 blue LED follows the signal coming out: off = -5V, on = +5V

Troubleshooting

Here is a shortlist of unexpected behaviors due to particular settings.

Remember that when in doubt of any setting, a long press on the encoder will scroll a help text.

Factory reset

In case you're completely lost with the settings or want to start with fresh out-of-box settings, there is a factory default reset function. Hold the LFO and Qtz buttons before powering up. Once you see the scrolling message, you can release the buttons.

The tuning potentiometers do not respond

Pot locking is engaged. See chapter: Locking the shared potentiometers
Beware that locking the tuning pots is a separate setting for each section!

No sound out of VCO1

The FM/AM jack is configured for VCA and there's no positive voltage coming in.
See chapter: FM/AM/... jack.

No signal in LFO mode

- The out level is closed; turn the Fine/Level pot up with the pot's white LED being on
- There is a negative voltage on the FM/AM jack

LFO is stuck

The Qtz/Clk LED is on; the LFO expects an external clock which is missing or so much divided that it seems stopped.

See chapter: Internal/external clocking – Qtz/Clk button

The normalised signal seems missing

If the signal source is in LFO mode, its (Fine/)Level knob is maybe closed.

If the source is VCO1 with VCA active, it may lack a control signal to open its VCA.

VCO tracking is odd

- VCOs play according to strange transpose relation. V/Oct setting is put to added or offset.
See chapter: V/Oct input jacks
- You have engaged some unusual quantizer scale.
See chapter: Quantizer – Qtz/Clk button
- You are using a poorly designed buffered multiple
- You are using a passive multiple and the driving module is not linear over the entire voltage range

Overall topology

The drawing does not account for the fact that shared settings are maintained while switching the controls between OSC1 and OSC2.

For simplification there is no representation of the VCF, ring modulator, additional oscillators etc, that are part of the various algorithms.

Neither are represented the various V.Oct input modes; only the Separate mode is shown.

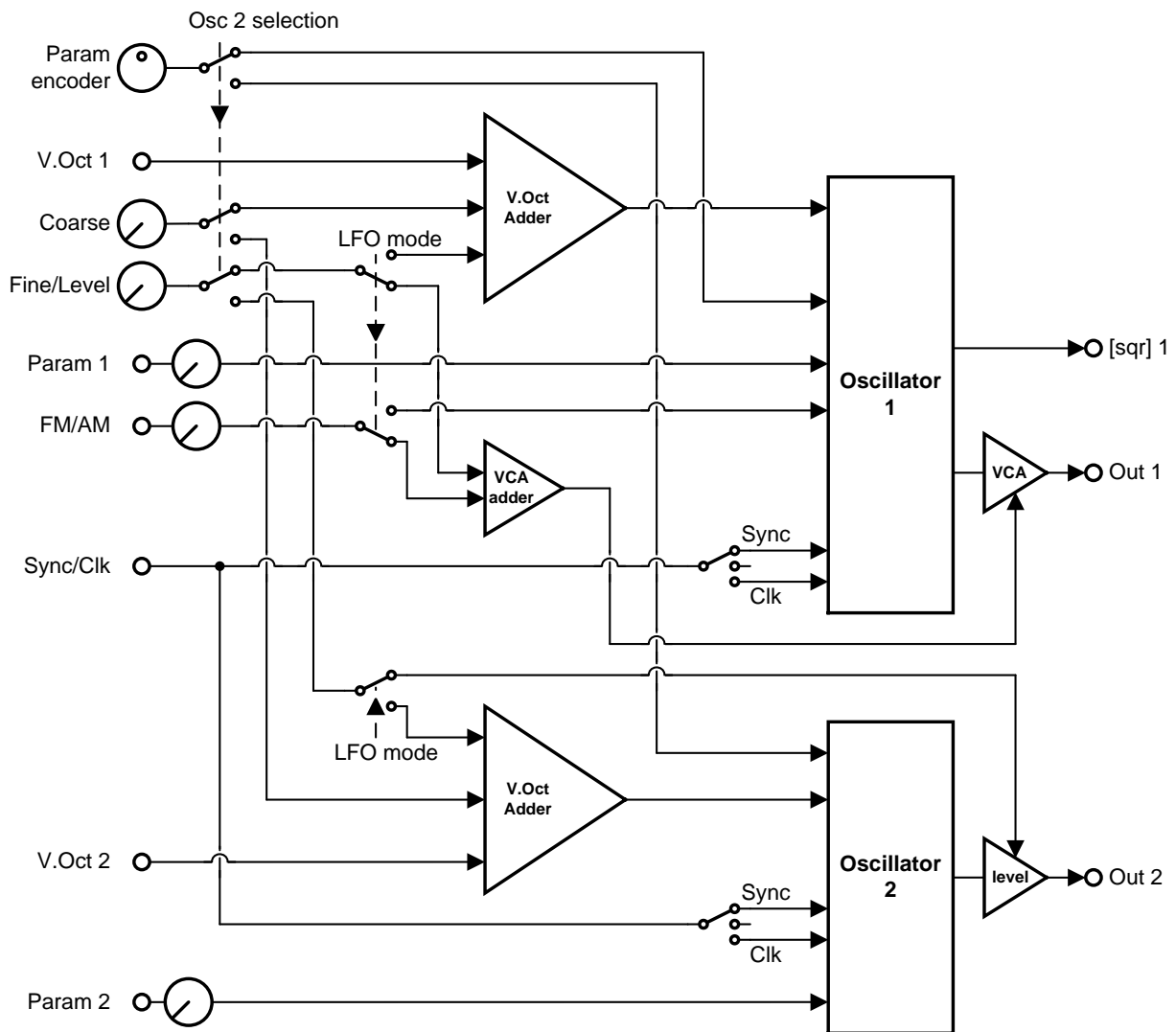

Specifications

Mechanical

Dimensions	mm	inches	Eurorack compliance
Height	128.40	5.06	3HE
Width	40.40	1.59	8HP
Depth behind panel (no supply cable inserted)	21.00	0.83	

Weight 73 grams/2.58 ounces (module only), 170 grams/6.0 ounces (boxed)

Supply

The supply socket is protected against reverse insertion.

Supply rail	Current draw
+12V	52 mA
-12V	17 mA
+5V	0 mA

Input/output

All inputs and outputs can withstand signals between -12V and +12V without harm.

Jack	Effective voltage range received or generated
V.Oct inputs	-4V to +6V
Param and AM/FM inputs	-3.75V to +3.75V min for full range
Sync/Clk input	+1.5V min for triggering
Outputs	-5 to +5V nominal

Signals

Parameter	Values
Fundamental frequency range in VCO mode	10Hz to 10KHz = over 10 octaves
VCO audio range (incl. harmonics)	DC to 20KHz
LFO frequency range (internal / external clocking)	2 minutes to 2KHz / several days to 2KHz
Input and output conversion	16-bit ADCs, 24-bit 96KHz DACs

Packing list

The box contains:

- Twin Waves MKII module
- 4x M3 black mounting screws + washers
- Eurorack-compliant 16/10 pin supply cable

Klavis products, including PCBs and metalwork, are designed and manufactured in Europe.