

Grainity Granular VCF

Digitally-controlled full-analog Granular + Multimode VCF

Introduction

The Grainity brings a unique and never-heard-before concept to the world of analog VCF. While being based on analog filtering only, the Grainity expands and enriches the sound in creating subharmonics, harmonies, unison, flanging effects and formant filtering all at once. The module presents two sections, the Granular filter itself and a typical Multimode filter, each with its own output. A third output offers a mix of both filter paths. Numerous controls and CV allow a very wide palette of results.

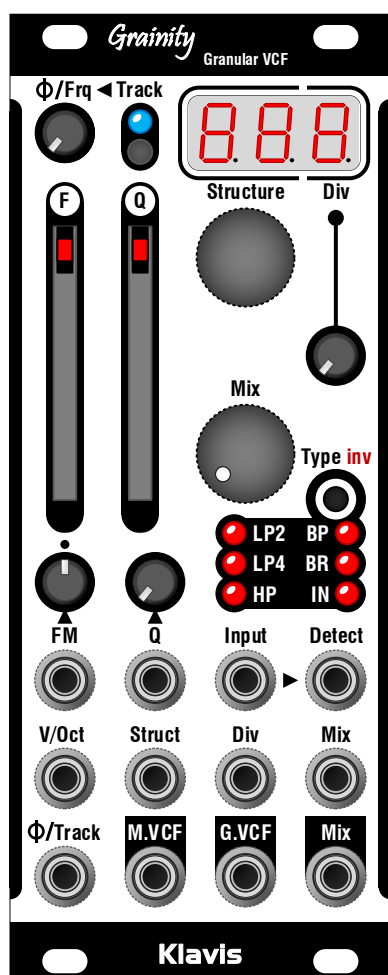

Features at a glance

- Unique concept of granular VCF
- 100% analog audio path
- Two simultaneous filter flows, Granular VCF and Multimode VCF, with separate outputs
- Mixing of both filter's output to a dedicated out
- Phase inversion switching between the two filters
- Shared frequency and resonance controls
- Multimode filter with various types and poles
- Self-resonance capability
- Granular filter with unique controls:
 - Structure selection from a predefined list
 - Division to extend the grains length
 - Phase setting of the cycling point
 - Tracking and offset tuning of the cycles
- Detect input for cycling unrelated to audio input
- 7 CV inputs to control all settings
- Current settings maintained over power cycle
- Firmware update via a simple audio file
- Scratch-resistant printed aluminum panel
- Compact and skiff-friendly module

Installation and security

Purpose

This module is meant for installation in a Eurorack-compliant chassis. It adheres to Eurorack Doepfer™ mechanical and electrical specifications.

Do not attempt using this module in other mechanical or electrical contexts.

Installation

Before the installation, disconnect the mains power supply from your modular system. Some power supplies are not safely isolated; there is a risk of injury!

See in the specifications if this module requires 5V from the supply rails. If 5V is needed and your rack is not providing 5V, do not attempt connection! A Klavis NoDrain adapter can provide the missing 5V rail.

Check that the current consumption requirements of this module, when added to your installed set of modules do not exceed the available current from your supply. This is done by adding up the current draw of all modules (mA) separately for each of 5V, 12V and -12V rails. If any of these 3 sums exceeds the available current of your supply for that voltage, do not connect the module to your system; you need a stronger power supply.

The provided supply flat cable can only be inserted in the appropriate orientation at the back of the module, so there is no risk of error on that end. However, you should pay attention to the orientation of the cable in the socket of the supply PCB inside your chassis. Cheap sockets without shrouding may allow you to plug in the connector the wrong way!

The red stripe on the cable should match a stripe printed on the supply board. The stripe also indicates the -12V side. In case there is no stripe, a -12V marking is a safe indication of the orientation.

Double check that the connectors are fully inserted and correctly oriented before switching on the power supply. In case of an anomaly, switch off the power supply immediately and check everything again.

Firmware update

If needed, the product can be updated by playing an audio file such as “Grainity_1.00.wav”.

Check on Klavis.com that you have the latest firmware version for your product.

If there is none to be found, there is none needed ;-)

Procedure

- Connect a mono or stereo cable between your audio playing device headphone output and the Grainity Struct input.
- Prepare to play the audio file
- Set the play level at two thirds
- While pressing the Track and Type buttons, switch on your modular case supply
- The display shows the current firmware version [Fxy], interpreted as “Firmware X.Y”.
- Start playing the audio file

If everything goes fine

- As the update is progressing, the display shows a value increasing towards 100
- When the blue Track LED flashes and the display shows the new firmware version, the updated was successful
- Press any button to restart the module

If the sound level is too low

- Stop audio playback
- Slightly increase the audio playback level
- Start audio playback from the beginning

If there is an error during the playback

The display will indicate [Err] and all red LEDs are flashing.

It is possible that the sound setting was too loud to begin with.

Diminish the sound level drastically and restart the procedure.

Playback error can also be due to various parasitic sound causes:

- Touching the cable
- Using sound-generating features of your phone or computer
- Some power saving feature affecting the audio playback
- Surrounding noisy modules, bad electrical grounding or modular supply noise
- Check that you have not created a ground loop (e.g. computer used as file player!)

What is the Grainity

Granular?

The word granular was chosen for this filter module in relation to the concept invented by the composer Yannis Xenakis, and which is described as assembling small chops of sounds - he called grains - according to a pattern. This is exactly what the Grainity does, no more no less ... but, digital control allows doing it in ways that are decades away from what tape and scissors allowed at the time.

Technology wise ...

In the granular section, the incoming sound cycle is determined in order to step through various filtering and phase variations of itself according to predefined patterns. The controls allow alterations to the phase, frequency offset and frequency division of the filters cycling. This comes in addition to the usual filter frequency and resonance controls.

What the Grainity is not

Technology wise ...

Despite relying on a microprocessor, the Grainity is not a digital audio processor. At any time, the sound remains in the analog domain and goes through analog circuits from in to out. The onboard digital processor does not convert or generate audio signals; it is there to control the analog circuitry and manage the interface and display.

Sound wise ...

Several digital modules offering granular processing rely on layering the sound grains, which leads to blurry and cloudy textures. Layering of the grains is a late addition to the concept of granular synthesis and is not a mandatory feature of the concept. The Grainity does not use delay lines or sampling memory but is nevertheless true to the foundations of the granular synthesis concept.

The granular VCF in the Grainity is unconventional in that, most of times, it is not filtering the sound in the common expectation of removing something. Typically, the granular process adds more than it removes by expanding both the lower range, creating subharmonics, and the upper harmonic contents in multiples ways.

Signal flow and overview

Here is a conceptual representation of the Grainity controls and connections.

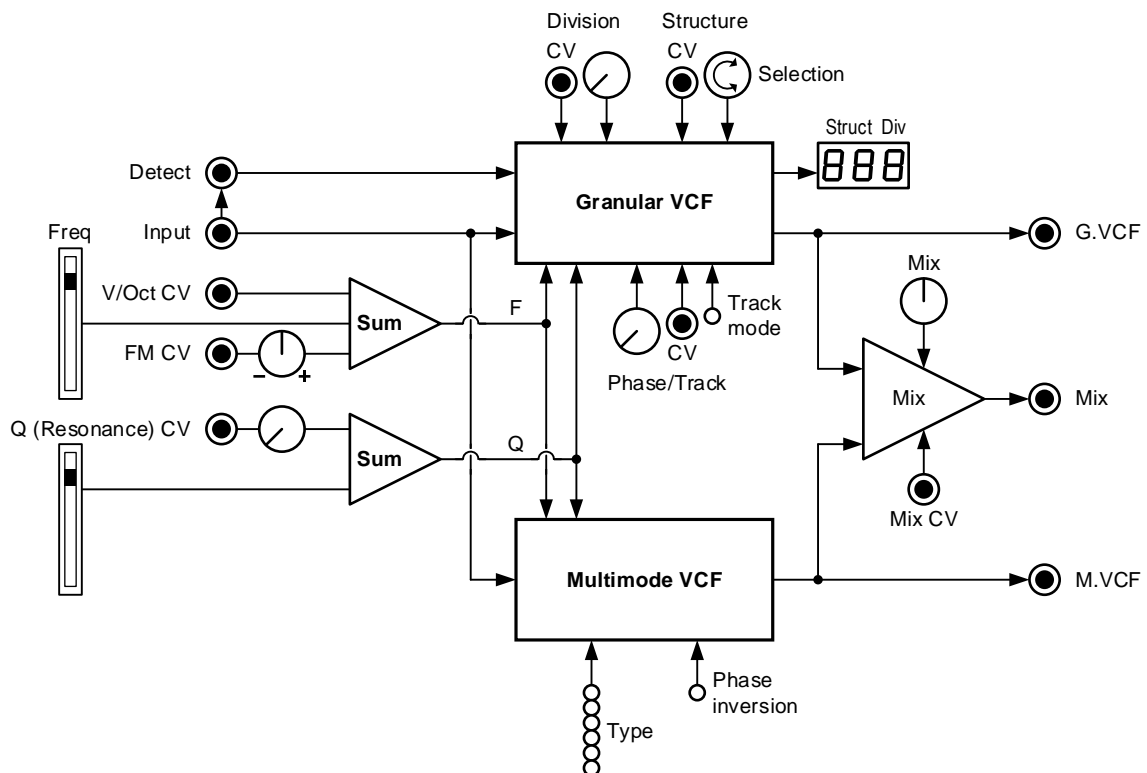

The incoming audio is feeding the Granular and Multimode sections. The granular filter has a Detect input that allows replacing the incoming audio detection with any arbitrary cycling signal.

Each filter section has its own output and settings; only the usual VCF frequency and resonance controls and their CV inputs are shared between both sections.

A dedicated Mix output with a knob and CV control allows balancing both filters.

A phase inversion setting between the two sections is useful when these are mixed; otherwise, it has no audible effect. Inversion usually reduces the fundamental tone, usually resulting in a thinner sound.

The output of the multimode filter is selected among various filter types.

The remaining controls are dedicated to the granular VCF and are explained further on.

Panel overview – shared and section dedicated controls

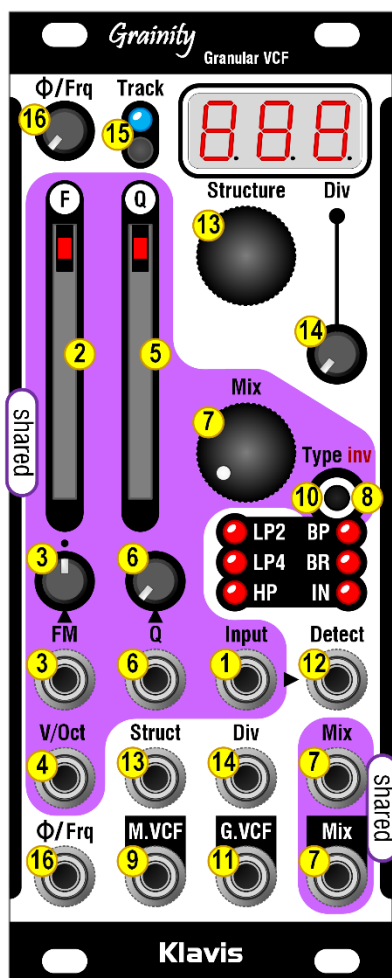

Shared controls

The knobs and jacks inside the colored area are shared between the two sections:

1. Audio input jack
2. Frequency fader
3. FM (Frequency) CV jack and its bipolar gain control knob
4. V/Oct CV jack
5. Q (resonance) fader
6. Q CV jack and its gain control knob
7. Mix output jack, Setting knob and CV input
8. Phase inversion push button (long press)

Multimode VCF controls

9. M.VCF, multimode VCF output jack
10. Filter mode selection LEDs and button (short press), with 6 options:
 - LP2, 12dB/Oct lowpass
 - LP4, 24dB/Oct lowpass
 - HP, 24dB/Oct highpass
 - BP, 12dB/Oct bandpass
 - BR, 12dB/oct band rejection also called notch
 - IN, the unaltered input signal; sometimes useful to blend with the rich granular result, especially using the Mix CV control

Granular VCF controls

11. G.VCF: granular VCF signal output jack
12. Detection input jack, for audio or trigger/gates
13. Structure: CV, selection encoder, and first two digits of the display
14. Divide: CV, Pot and the right digit of the display
15. Track mode button and LED
16. Phase/Frequency: CV and pot

Everything in detail

Shared settings

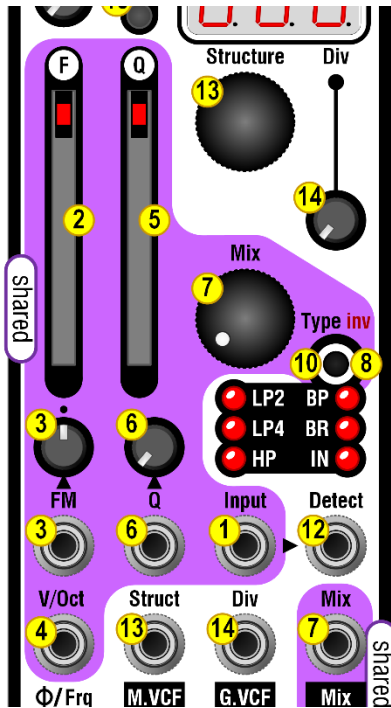

Overall frequency control

The V/Oct input (4), FM input (3), FM knob (3), and Frequency [F] fader (2) control the cutoff frequency in both filter sections simultaneously. The CVs from FM and V/Oct are added to the fader position.

The FM knob (3) has its zero level at middle setting, indicated by a small dot. From there, turning to the right increases the amplitude of the modulation; going to the left increases its inverted polarity. (e.g., an LFO saw wave can be made rising or falling as needed)

The V/Oct input (4) is reasonably following a 2F/Volt ratio; adequate for tracking filter purposes.

In use: Bring the V/Oct signal that drives your VCO to the Grainity V/Oct input to have tracking filtering that follows the melody.

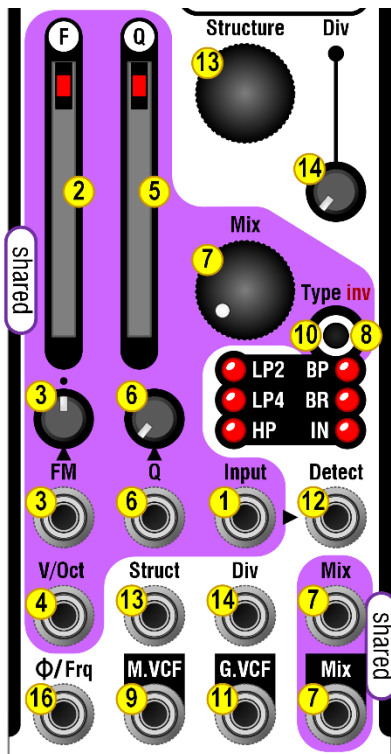

Overall resonance control

The Q input (6) and fader control (5) the amplitude of the peak at the cutoff frequency point. The Q input offers a level control pot (6) for the modulating signal.

Mix knob

This knob (7) balances the multimode VCF (full left) and granular VCF (full right) outputs being mixed to the Mix out (7). In addition, the Mix can be voltage controlled (7).

When pressed long, the Type/inv button (8) inverts the signal polarity between the two filter sections. A sufficient long press is indicated by a LED blinking.

Inversion active is indicated by dark blips on the currently selected filter mode LED.

The multimode VCF (M.VCF)

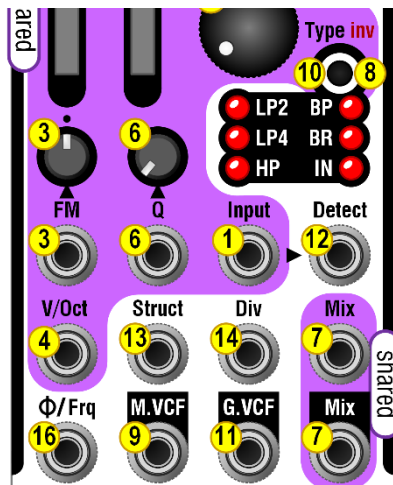

Filter Type

Short presses on the Type button (10) scrolls through the 6 output options of the M.VCF. (9)

The IN option is essentially used to be mixed with the G.VCF on the Mix output. (7)

The granular VCF

Here is the signal flow of the granular filter section

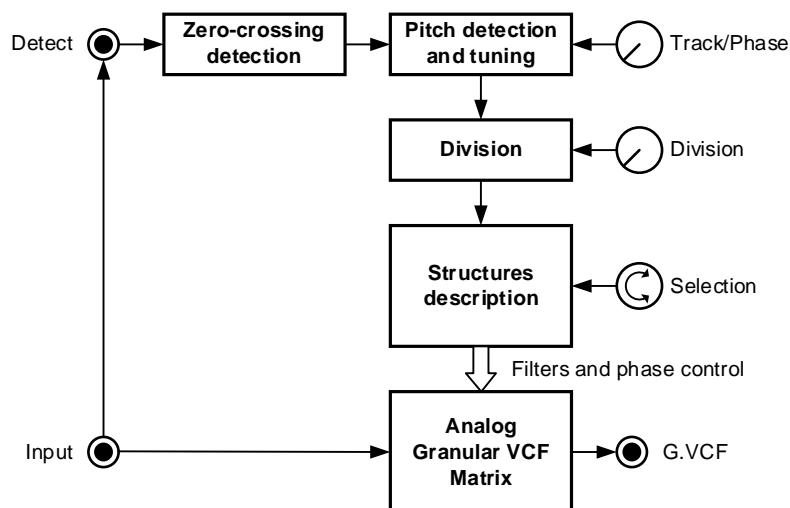

The whole granular engine reacts to the cycle of the incoming signal. In practice, it detects the zero-crossing of the signal going up. This generates a flow of triggering at audio rate.

Feeding a cyclic signal from a VCO is the basic usage. It means that the filtering defined in the structure will change at audio rate. Triggering by clocks, sequencers etc, is allowed instead of audio. This is done via the Detect input.

The Track and Phase functions only makes sense when driven by a cyclic audio signal. The Track function allows retuning the triggering in a musical way. Its range goes from x1 to x2.01. When not in Track mode, the knob adjusts the Phase of the triggering stream.

The Division setting reduces the rate of the triggering.

The triggering steps through the currently selected Structure in a loop. Structures are definitions of filter and phase combinations.

Cycling

Simple VCO waves have usually one zero-crossing per cycle. A 1kHz note will step the granular engine 1000 times per second.

Some sound sources will trigger the stepping more than once per cycle. It is highly recommended to explore that domain as it leads to unexpected and interesting results.

- **Additive synthesis** waves have usually several zero-crossings per cycle. Moreover, the number of zero-crossings can change as the waves build up with additional harmonics.
- Due to the sliding of the phase/counterphase relation in their content, **Unison sounds** present a permanently evolving zero-crossing behavior.
- **Synced waves** present another very interesting zero-crossing triggering as they essentially combine two fundamental tones within each global cycle.
- **Ring modulator** audio sources lead to highly atonal filtering in addition to their inherent inharmony.
- **Polyphonic** signal (chord of a given sound) can lead to harmonically related zero-crossing with additional cycling highly dependent of the chord content.
- **Mixed sound source** and **percussive sounds** will usually lead to chaos, which is maybe what you need. There are ways to tame things though; see Cookbook chapter.

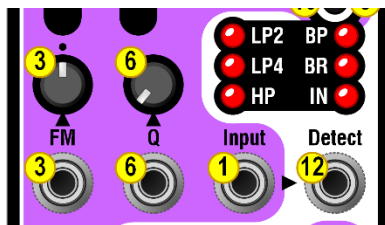

Detect input (12)

This input drives the granular engine in place of the audio signal at the main input (1). This allows a number of interesting variations. The detect jack (12) accepts audio or any triggering/LFO signal.

Signal at Audio input	Signal to experiment at Detect input
Polyphonic sound (chord)	One of the notes from the chord - usually the lowest
Atonal sound: <ul style="list-style-type: none"> • Drums • Mixed music • Noise 	Unrelated VCO to superimpose a tone/melody to the source
Multiple zero-crossing: <ul style="list-style-type: none"> • Synced waves • Additive synthesis 	Derived simple wave from the same VCO for perfect tracking by avoiding the multiple zero-crossing at the audio input
Anything tonal or not	Noise, ring modulated source, polyphonic sound, or anything else. This will usually mangle the signal in an aggressive way
	Triggers at BPM rate from an LFO, sequencer, ... This is used to create low-rate filter sequences



The Φ (phase)/Frq knob (16) and the track button (15)

Phase mode and Track modes are exclusive and depend on the Track button + LED (15) being on/off.

Track button off = Phase control

With the pot (16) set to minimum, the cycling of the granular filter occurs as soon as a zero-crossing is detected. Increasing the pot delays the phase position within each cycle. The cycling delay adjusts automatically to the frequency of the incoming signal.

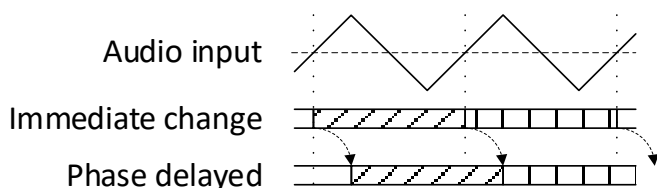

The phase setting usually offers subtle tonal variations typical of phasing and flanging effects. Depending on the sound source, when phase is CV modulated, it sounds similar to a unison effect. However, there's a difference:

- With an actual unison sound, the beating rate accelerates as the pitch of the audio signal gets higher (twice as fast with every octave)
- With a CV modulation of the phase delay, the shifting is unrelated to the pitch

Track button (15) on = Track control

Track control is another way of applying the filter cycling on the incoming signal. Instead of using the audio signal's zero-crossing as is, its audio frequency is determined, then the resulting pitch is musically (de)tuned to become the cycling trigger. For example, entering a C pitched note and detuning it to G will cycle the granular filter 3 times over the duration of 2 audio cycles of the incoming sound. This 3:2 ratio will follow the incoming pitch automatically.

This Tracking function can be seen as some kind of virtual VCO. However, it doesn't create any sound; only its cycle triggering is used to control the filtering.

The tuning Frq knob (16) goes from unison up to one octave higher with every pitch in between. The cycling can create all kind of harmonically related pitches through filtering while benefitting of a unison-like fine detuning.

If the detection of the zero-crossing does not allow identifying a reliable frequency, the tracking and thus the cycling could be unpredictable. It is however suggested to use chords, unison, etc, for interesting results.

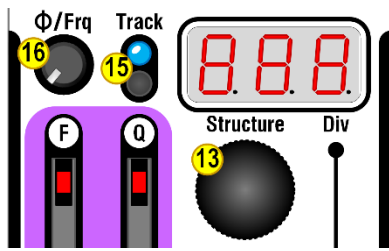

The structure selector (13) and display

The structure selection is shown in the two first digits of the display.

The structures are pre-programmed sequences of filtering options. They are defined by their length (loops of 2 to 8 steps) shown in the first digit, and their variation in the second digit. They are organized in lists, according to their length.

Maintaining the encoder knob (13) pressed while turning allows quickly switching through the length lists. It might be useful bringing a voltage from a fader or knob to the Structure CV input (13) for a quick evaluation and selection of the structure.

The longer the sequence the more subharmonics and the lower sub-octaves will be in the end result. When playing melodies through long structures, it makes sense to increase the octave of the source.

At the end of the length lists is a list of random structures indicated by a [r] in the first digit. These are not predefined as a fixed sequences but by an algorithm. Each random Structure has an allowed content and a mathematical distribution; these are applied in a truly random manner.

The Grainity's microcontroller relies on an analog noise source for its random generator ;-)

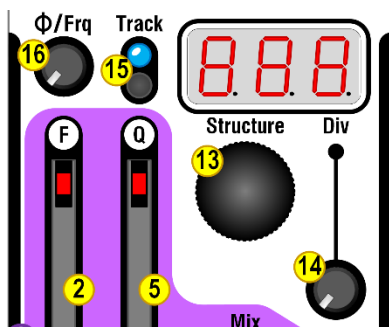

The Div pot (14) and display

The division setting is shown in the last digit of the display. The division applies to the cycling signal whatever its source and treatment. Division occurs after the detect, phase and track settings are applied. The division tells how many times a step in a structure is repeated before changing to the next content in the loop.

Display	1	2	3	4	5	8	A	b	c	d
Division	1	2	3	4	5	8	16	32	64	128

There are various domains of application for the division setting:

- With small values, it is possible to create another “layer” of related harmony. This works effectively well in conjunction with the Tracking which increases the cycling rate (= higher pitch) before being divided. Carefully choosing these two settings can create 3-note chords from a single VCO signal.
- Small values are also used with clock/seq/LFO triggering on the Detect input
- Big divisions are used to create filtered rhythmic patterns whose rate follows the pitch of the incoming audio

Grainity's cookbook

Dealing with complex sound sources in the granular section

VCOs

Sound sources with more than a single zero-crossing per cycle are a creative way of using the granular VCF. This is especially true when the VCO presents controls or CVs that drastically change its harmonic content. But sometimes, you would prefer having a related ratio between the incoming wave and the Grainity filter stepping so that the G.VCF behaves more predictably.

When using a VCO that presents multiple waves at once, connect the “wild” wave to the main input while a secondary wiser wave is sent to the Detect input.

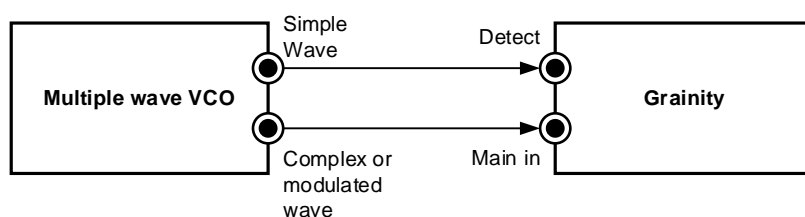

When using the Klavis Twin Waves, the Sqr1 out can serve as the “simple wave”. This allows you using the additive, unison, ring-modulation and self-sync algorithms as “simple waves”. It is welcome to activate the Track mode and find a suitable tuning.

Chords

The trick is to let only one of the voices guide the filtering in harmony; this is why the lowest note is suggested.

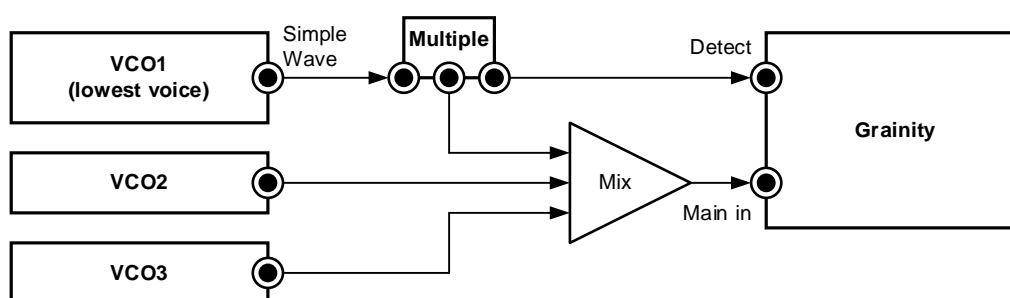

Percussion

Percussive sounds are typically inharmonic leading to random filtering. Here are two options for more control.

1. Using a VCO in the Detect input impose a filtering pitch.
If the percussion sound generation is controlled by a pitch CV, you can also apply this CV to the VCO driving the Detect input.

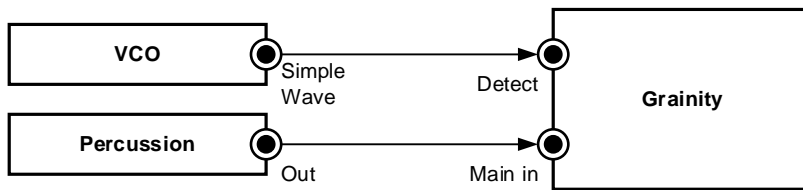

2. Change the filtering at one step per occurrence.

This is simply done by using the trigger or gate used to create the percussive sound connected to the Detect input.

Mixed music

The goal is to use some particularity of the sound source to create the G.VCF step triggering. This will typically be rhythmic element present a prominent frequency band (e.g. low for kick or bass, highs for a hi-hat, etc).

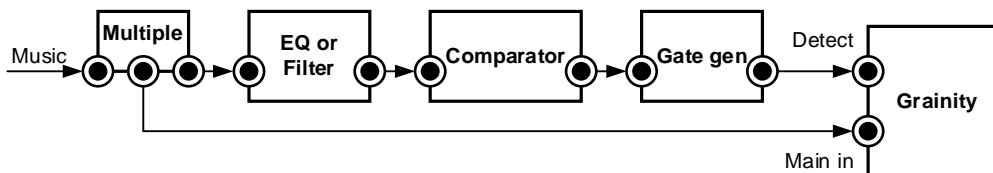

The comparator ensures that there will be a triggering only when the amplitude in the selected frequency range is high enough; the Gate generator prevents parasitic retriggering by extending the trigger length once it is detected. Both functions can be realized with a single Klavis Two Bits logic module.

A simpler way to process mixed music is to detect only the peaks in the overall level by inserting a volume control. Given that the Detect input is very sensitive, it is needed to reduce the level quite drastically.

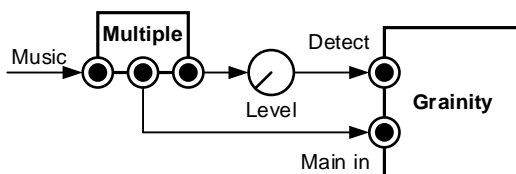

Chorus effect

Modulating the Phase with a slowly evolving LFO provides a nice phasing or flanging-like effect depending on the Structure selected. To create a chorus effect you can modulate the phase with an irregular evolving signal such as a slewed sample-and-hold of noise or ideally better a vector modulation generator such as found in the Twin-Waves.

Stereo

Sometimes, the settings of Track and Structure provide a GVCF sound that seems unrelated to the incoming sound. Usually this is when the resulting pitch of the GVCF is not present in the source. In such case it might be interesting to use the MVCF and GVF as two independent channels.

Structures

2-step loops		
Family	Display	Your notes
Low-pass	2A	
	2b	
High-pass	2c	
	2d	
Band-pass	2E	
	2F	
All-pass	2G	

3-step loops		
Family	Display	Your notes
Low-pass	3A	
	3b	
	3c	
	3d	
High-pass	3E	
	3F	
Band-pass	3G	
	3H	
	3J	
All-pass	3L	
	3n	
	3o	

4-step loops		
Family	Display	Your notes
Low-pass	4A	
	4b	
	4c	
	4d	
	4E	
	4F	
	4G	
High-pass	4H	
	4J	
	4L	
	4n	
Band-pass	4o	
	4P	
All-pass	4r	

5-step loops		
Family	Display	Your notes
Low-pass	5A	
	5b	
	5c	
	5d	
High-pass	5E	
Band-pass	5F	
All-pass	5G	

6-step loops		
Family	Display	Your notes
Low-pass	6A	
	6b	
	6c	
	6d	
	6E	
All-pass	6F	
	6G	

8-step loops		
Family	Display	Your notes
Patterns using any filter options	8A	
	8b	
	8c	
	8d	
	8E	
	8F	

Eight-step loops are usually too long to be cycled at audio rate. The ones offered here were selected for their rhythmic musicality when triggered as sequences.

Trimming the V/Oct setting

The V/oct CV control varies with the temperature. The factory default setting works reasonably well for filter tracking. The adequacy of that setting will depend of your usual environment for the module (case and room).

Nevertheless, if you want to improve the setting, it can be user-adjusted from the front panel.

Procedure

- Switch on the Grainity's case in a room whose temperature is stable for at least an hour
- Switch off the case
- Keep the Structure encoder knob pressed while powering on until you see [Oct]
- The display then shows the last set value (zero when new)
- Put the M.VCF to bandpass and connect it to some listening means
- Push the Q fader to maximum
- Do not bring any signal to any input except some V/Oct source to the V/Oct input (keyboard, sequencer, ...)
- Adjust the F fader somewhere halfway
- Using your V/Oct source switch octaves
- Use your ears, a tuner, or a frequency meter to evaluate the adequation of the setting at various octaves
- Adjust the V/Oct setting by turning the encoder (negative/positive values)
- When done, press the encoder knob
 - Your setting is stored in non-volatile memory
 - The display shows [Sto] for one second
 - The module resets
 - The procedure is over

Specifications

Mechanical

Dimensions	mm	inches	Eurorack compliance
Height	128.40	5.06	3HE
Width	50.6	1.99	10HP
Depth behind panel (without supply cable)	21.00	0.83	

Supply

The supply socket is protected against reverse insertion.

Supply rail	Current draw
+12V	101 mA
-12V	59 mA
+5V	0 mA

Input/output

All inputs and outputs can withstand signals between -12V and +12V without harm.

Jack	Effective voltage range received or generated
Audio input	+/-5Vpp nominal, DC coupled
Detect input	0.1V min, rising edge, AC coupled
CV inputs	+/- 5V
Q CV input	0~5V
Outputs	Gain x1 from input, with open filter and no resonance

Packing list

The box contains:

- Grainity module
- 4x M3 black mounting screws + washers
- Eurorack-compliant 16/10-pin supply cable

Klavis products, including PCB and metalwork, are designed and manufactured in Europe.